

Charlton & Jenrick^{LTD}

Best of British fires, fireplaces & stoves

LED Electric Fire

Model: Polaris 620

INSTALLATION AND OPERATION INSTRUCTIONS

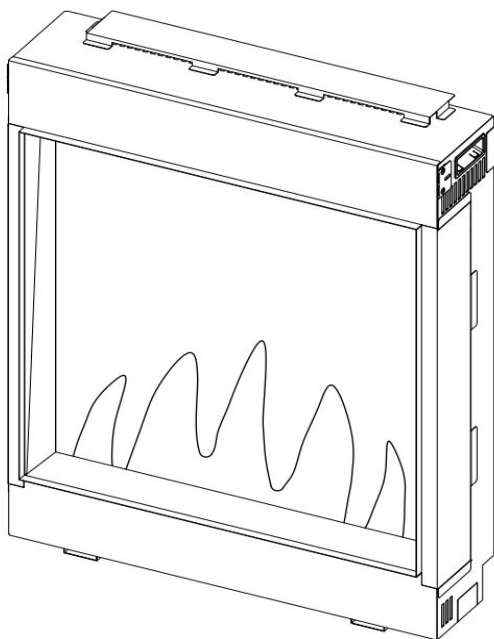

Please read the instructions carefully before installation or use and keep for future reference

CONTENTS

1. Important Safety Information	2
2. Technical Specifications	3
3. Parts and Hardware	4
4. Appliance Dimensions	6
5. Installation Instructions	6
6. Operating Instructions	15
6a. Manual Control Panel	16
6b. Remote Controls	17
7. Maintenance	23
8. Others	24

1. IMPORTANT SAFETY INFORMATION

- 1.1 Read all of the instructions carefully before using the appliance.
- 1.2 For indoor use only. This appliance is not suitable for use outside the house and only suitable for well insulated spaces or occasional use.
- 1.3 Do not use this appliance in the immediate surroundings of a bath, a shower or a swimming pool.
- 1.4 Do not use this fire as a free-standing appliance. It must always be fixed to the wall, fireplace mantel, floor etc.
- 1.5 This fire must not be located immediately below a socket-outlet.
- 1.6 This appliance must be earthed.
- 1.7 This appliance must not be supplied through an external switching device, such as a timer, or connected to the circuit that is regularly switched on and off by utility in order to avoid a hazard due to the inadvertent resetting of the thermal cut out.
- 1.8 If the power cord is damaged, it must be repaired by the manufacturer, its authorised service centre or professional person.
- 1.9 **Warning:** in order to avoid overheating, do not allow the appliance to be covered or let the air inlet/outlet become obstructed. Please note the warning on the appliance.
- 1.10 To reduce the risk of fire, keep textiles, curtains, or any other flammable material a minimum distance of 1 meter from the air outlet.
- 1.11 Keep the power cord away from hot surfaces and hot conditions. Do not route the power lead in front of the appliance.
- 1.12 Do not use this fire in rooms that have explosive gas in them (for example petrol), or if you are using solvents, glue, aerosol spray or in flammable paints, as these may catch fire.
- 1.13 This appliance can be used by children aged from 8 years and above and persons with reduced physical, sensory or mental capabilities or lack of experience and knowledge if they have been given supervision or instruction concerning use of the appliance in a safe way and understand the hazards involved.

- 1.14 Children and vulnerable people must be supervised at all times when using this appliance, as some parts can become very hot and cause burns. A suitable fireguard must be fitted for this purpose.
- 1.15 Do not use this appliance in small rooms when they are occupied by persons not capable of leaving the room on their own, unless constant supervision is provided.
- 1.16 Cleaning and user maintenance shall not be made by children without supervision.
- 1.17 Keep the power plug accessible after installation.

2. TECHNICAL SPECIFICATIONS

Model No.: Polaris 620
 Supply Voltage: AC 230-240V 50Hz
 Maximum power consumption: 1800-2000W
 Power for flame effect: 30W
 Max. power for mood light: 30W

Heat Output:

Nominal heat output (Pnom): 2000W
 Minimum heat output(indicative) (Pmin): 1000W
 Maximum continuous heat output (Pmax): 2000W

Auxiliary Electricity Consumption:

At nominal heat output (elmax): 12.5W
 At minimum heat output (elmin): 12W
 In standby mode (elSB): 0. 8W

Type of heat output / room temperature control



Single stage heat output and no room temperature control	No
Two or more manual stages, no room temperature control	No
With mechanic thermostat room temperature control	No
With electronic room temperature control	Yes
Electronic room temperature control plus day timer	Yes
Electronic room temperature control plus week timer	Yes







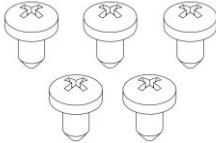
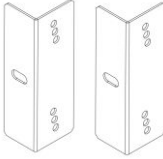
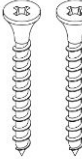
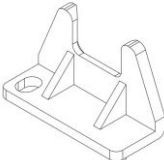



Other Control Options

Room temperature control, with presence detection	No
Room temperature control, with open window detection	Yes
With distance control option	No
With adaptive start control	Yes
With working time limitation	No
With black bulb sensor	No

3. PARTS AND HARDWARE

- 3.1 Unpacking the fire carefully, make sure that the appliance is intact with no signs of damage caused by transport and no part has been exposed to water. If in doubt, do not use the appliance and contact an authorised service centre.
- 3.2 Keep plastic wrapping away from children.
- 3.3 Save the original packaging as this may be required in the event of service complaint with product.
- 3.4 Check that all parts are removed from the packing.

<p>A</p> 	<p>B</p> 	<p>C</p> 
<p>ST 4* 8 Flat-tail Screws (5 pcs)</p>	<p>Brackets (2 pcs)</p>	<p>ST 4*40 Rat-tail Screw (2 pcs)</p>
<p>D</p> 	<p>E</p> 	<p>F</p> 
<p>Power Cord Bracket (1 pc)</p>	<p>Masonry Anchor (10 pcs)</p>	<p>ST 5*40 Screws (10 pcs)</p>

<p>G</p> 	<p>H</p> 	<p>I</p> 
<p>Black Glasses (1 set)</p>	<p>Vermiculate (1 set)</p>	<p>Logs (1 set)</p>
<p>J</p> <p>Charlton & Jenrick Best of British Fires, England & more</p> <p>LED Electric Fire MADE IN CHINA 962220022010 INSTALLATION AND OPERATION INSTRUCTIONS</p>  <p><small>PLEASE CONTACT THE MANUFACTURER FOR A FULLY DETAILED INSTALLATION OR USE MANUAL FOR YOUR MODEL</small></p>	<p>K</p> 	<p>L</p> 
<p>Instruction Manual (1 pc)</p>	<p>AAA Battery (2 pcs)</p>	<p>Remote (1 pc)</p>
<p>M</p> 	<p>N</p> <p>Quick Guide to Operating Basic Functions</p> <p>Important: First the control must be put into Normal Mode and you must ensure you stay in NORMAL MODE to operate these functions in the simplest way.</p> <p>Turn On Appliance If the appliance is in the standby condition (refer to: Standby mode). Press and ON to turn on the appliance from the standby function.</p>  <p>Normal Mode Press ON to enter the normal mode if you have already pressed this repeatedly until M appears and the last 18°C appears at the main part of the screen. You can also use the remote. MODE (M) ON 18°C and programme setpoint.</p>  <p>To Control the Heat Press ON to set on screen. Press the UP and DOWN buttons to adjust the setting temperature from 17°C to 21°C in 1°C increments. Press ON to return to the normal heat. Note: Screen will show the lower of the screen.</p>  <p>NOTE: It is essential for the heat heater to stop heating for periods of time. This happens because the room temperature is not above the temperature set on the thermostat.</p>	
<p>Power Cord (1 pc)</p>	<p>Simplified Instruction (1 pc)</p>	

4. APPLIANCE DIMENSIONS

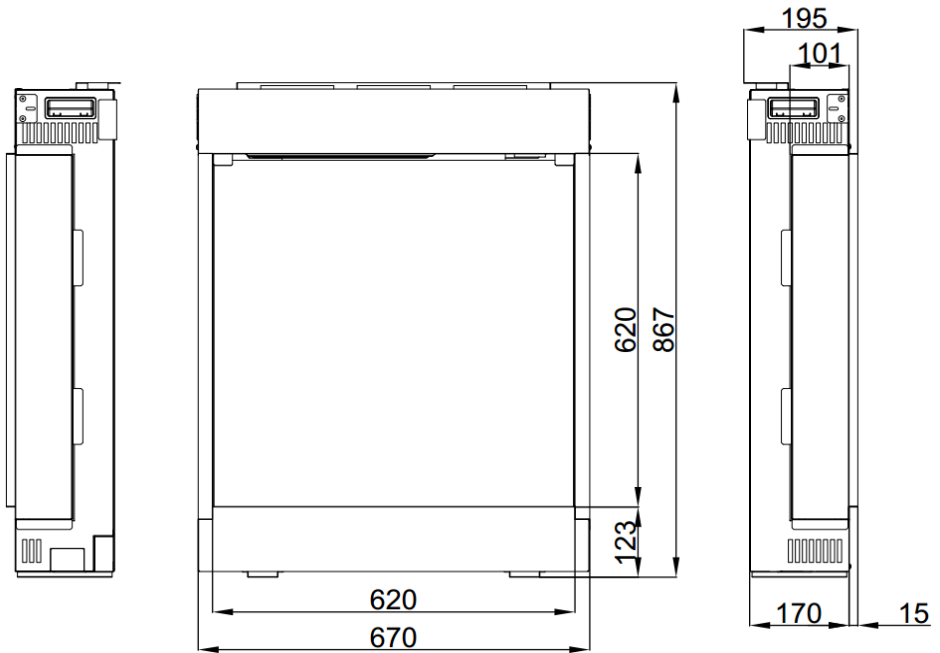

Unit: mm

5. INSTALLATION INSTRUCTIONS

Tools Required

A screwdriver a spirit level and drill will be needed.

Locating the Appliance

Your new electric fireplace may be installed virtually anywhere in your home. However, when choosing a location ensure that the general instructions are followed.

5.1 For best results, install out of direct sunlight.

5.2 If installing in an existing fireplace and chimney always block the chimney with fibreglass insulation or similar, to prevent it sucking air away through

the appliance. Failure to do this may cause poor performance and loss of heat or make the appliance cut out.

5.3 The appliance should be connected to an earthed electrical outlet and it must be easily accessible to allow disconnection.

The wires in the mains cable of this appliance are colored in accordance with the following code: Blue = Neutral. Brown = Live. Green/yellow = earth.

PREPARATION BEFORE INSTALLATION

The appliance can be installed in 3 different arrangements, the intended arrangement should be considered before starting the installation. They are as follows :

- Single front aspect (This is where the appliance is installed so that only the front window is visible)
- Duel aspect (this is where the appliance is installed so that the front and one of the side windows are visible)
- Triple aspect (this is where the appliance is installed so that the front and both side windows are visible)

5.4 When you unpack the appliance, you will note the angle trimming edges are fastened at each side over the side plates. Firstly, they need to be removed and if you are installing as a duel or triple aspect then the appropriate side plate(s) should also be removed.

Replace the angle trimming edges to any side you have removed the side panel. This will facilitate a finishing edge for plasterboard or panelling.

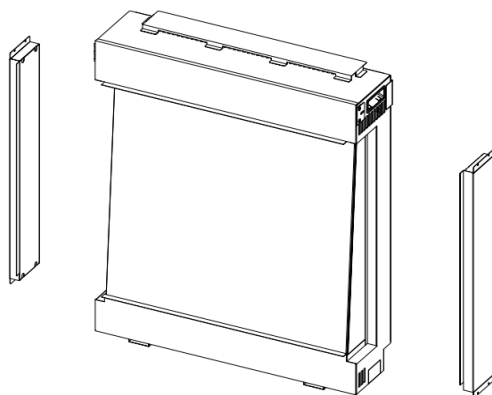

5.5 The main electric connection to the rear of the appliance is via a kettle plug, it is very important that the plug is fully located in the socket and the plastic retention clip that is provided is fitted and secured with the 1 screw provided. We further recommend that the power is turned on and the appliance is operated to check function and prove the power connection is sound.

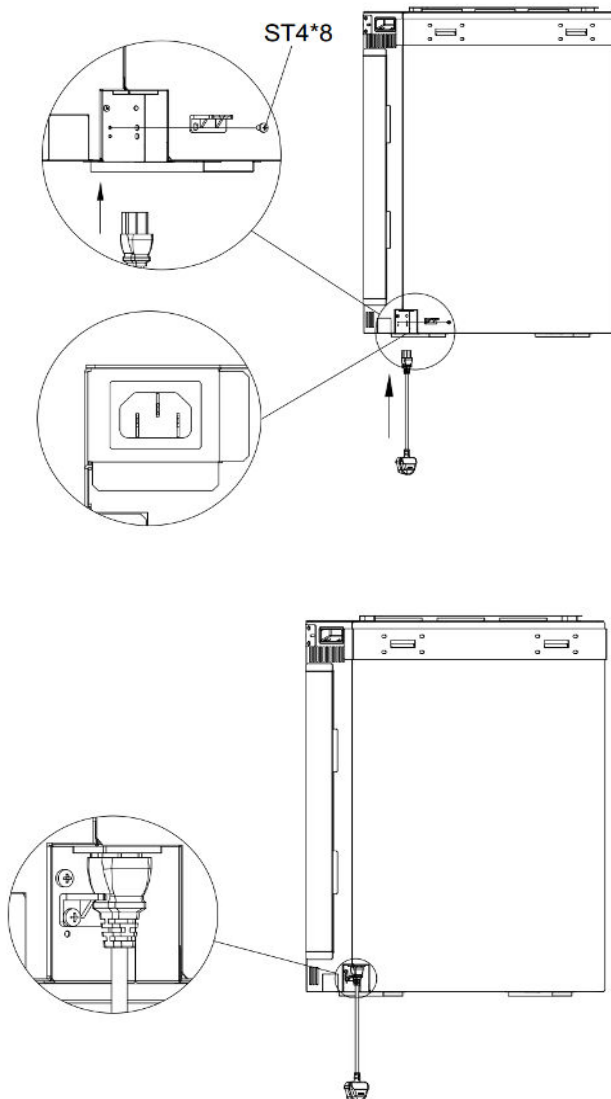

5.6 If you intend to use mood lights, then you need to prepare the appliance before fixing into the feature. Prepare as follows: **(Note: Mood lights are an optional extra.)**

5.6a Remove the two ST4×10 screws and the metal plate on the right lower side. Pull out the cable inside, make the connections with the components, in accordance to the mood light instructions

5.6b Refit plate with two ST4×10 screws and connect the mood light strip, various lengths available (max length 6 metres).

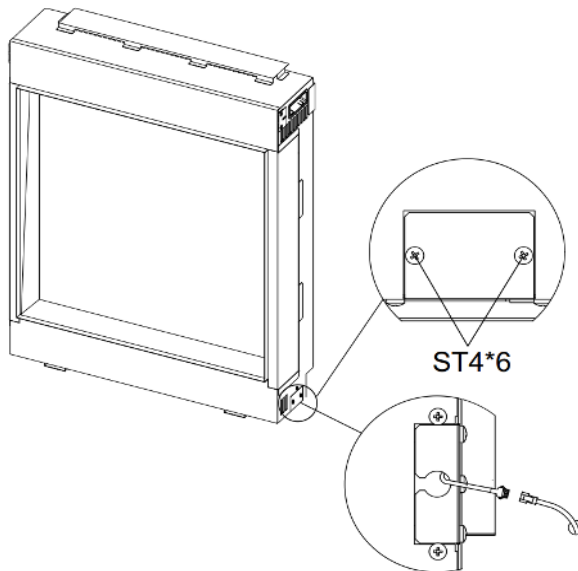

Note: Compatible mood lights are available from Charlton & Jenrick Ltd., and other makes may not be suitable and will void warranty.

5.6c When mood lights are fitted, they should be checked for operation before the access is closed off by the installation.

5.7 Installation

The following is only given as a general guide because it can be installed in so many ways. Provided you ensure air can freely enter

the top and bottom. Ensure electric connections are safely made in accordance to the codes. A multitude of materials may be used from the framework and cladding.

All service work can be carried out via the front of the appliance, so no special access is required.

5.7a Installation into a framework

5.7a1 Prepare the framework as picture:

Similar, if mood lights are fitted, they should be checked for operation before the access is closed off by the installation.

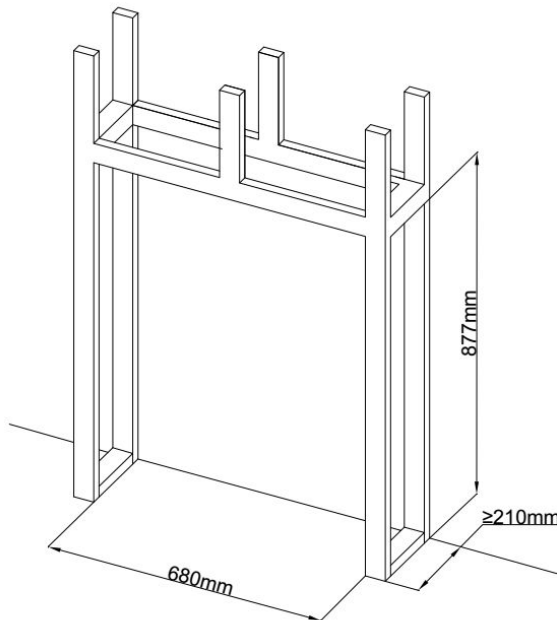

5.7a2 Fit top vent cover, so that it projects 10mm from rear of appliance.

NOTE: Consideration must be given to ensure that air can enter the vents on the underside of the appliance and the top of the appliance.
The appliance is fitted with feet to support the appliance. Please don't block underside between the feet.

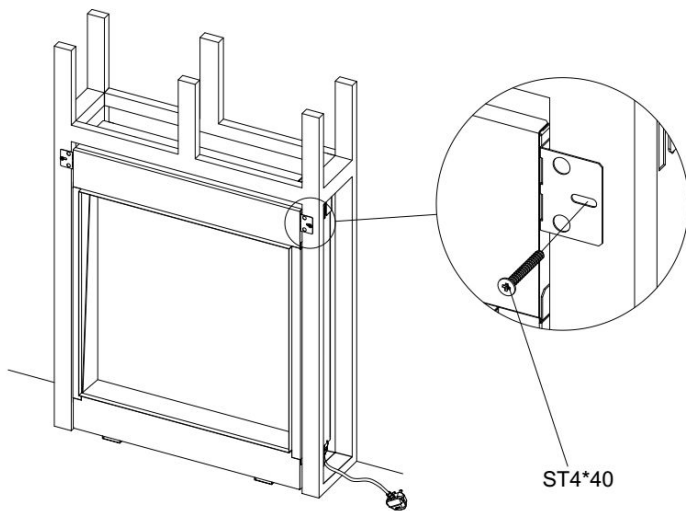

5.7a3 Position the appliance into the framework and secure it using fold out the brackets on the top and lower edge of this appliance.

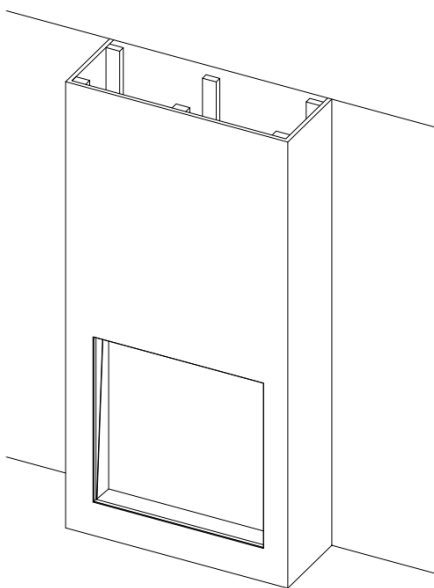

5.7a4 Cover the framework by panels or plaster board, it can be used directly against the sides and front of the appliance.

5.7b Installation of hanging on the wall

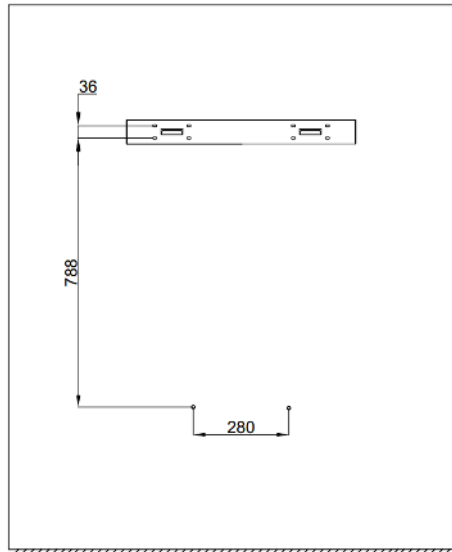
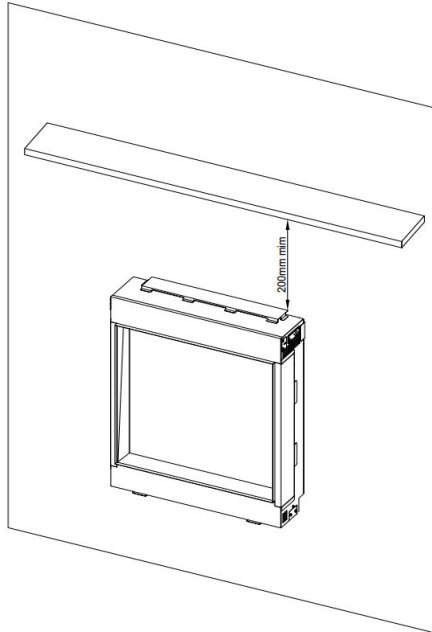

UNIT:mm

- 5.7b1 Fit top vet cover so that it's flush to the rear edge of the appliance
- 5.7b2 Measure from the lowest point of the appliance to the top edge of the wall bracket, it is currently fixed to the rear of the appliance.
- 5.7b3 Remove the wall bracket from the rear of the appliance.
- 5.7b4 Add the height you require the base of the appliance to be from the floor to the earlier measurement.
- 5.7b5 Use this new measurement to mark the wall up from the floor surface.
- 5.7b6 Offer the top edge of the bracket to this mark and ensure it is horizontal using a spirit level.
- 5.7b7 Carefully mark through the holes in the wall bracket.
- 5.7b8 Use the marks to drill holes in wall to fix wall bracket
- 5.7b9 Carefully hang the appliance on the wall bracket
- 5.7b10 Check the appliance front face is vertical (parallel to the wall)
- 5.7b11 If it not pull the lower edge from the wall until vertical and note the distance from the rear to the wall at the base of appliance.
- 5.7b12 Remove the appliance from the wall bracket and place upside down on the floor
- 5.7b13 Fix the 2 pcs of the lower wall spacers with the screws provided, selecting to hole that is closest spacing off the engine the dimension determined earlier
- 5.7b14 Carefully hang the appliance again on the wall bracket, check it is now vertical.
- 5.7b15 If you are satisfied that it's vertical then mark through through bracket for wall fixings
- 5.7b16 Complete wall fixing by securing with ST5*40 screws.

5.8 Laying the fuel bed

- 5.8a Remove the front glass panels by removing the thumbscrews and lower fixing brackets and then remove the front glass by pulling forward and lifting out of position.

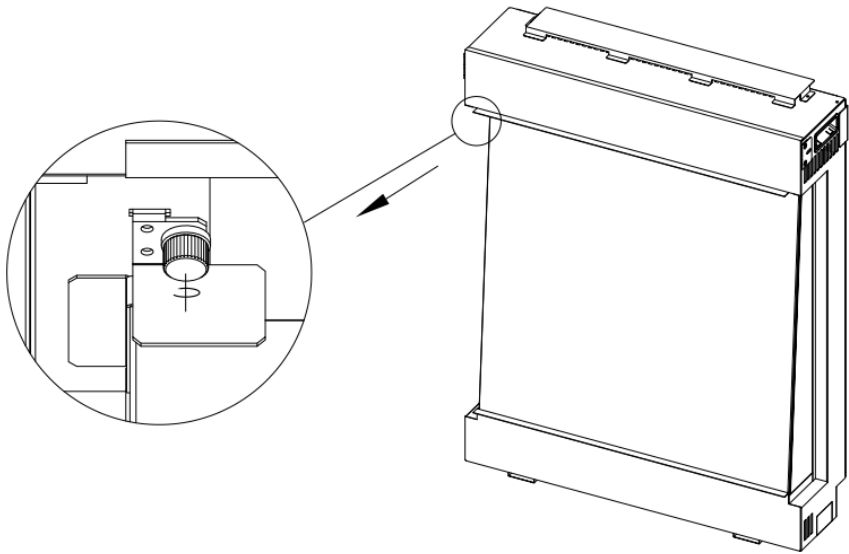

5.8b After removing the glass front panel turn on the appliance on and you will see low down on the back panel some groups of red lights.

5.8c These are reflections of LED lights under the front edge of the fuel bed area. So using the glass ember components provided put them tightly against the front edge in a position that blocks the reflection on the back panel.

5.8d When you are satisfied that very little reflection of these LED's can be seen on the back panel, randomly place the remaining glass ember components over the fuel bed area.

5.8e Now open the bag of vermiculite and sprinkle between the embers covering the remaining visible sections of the fuel bed area.

5.8f Finally, take your time and position the logs and bark pieces provided over the embers create the arrangement to your own taste (all the logs will fit onto the appliance, but if you wish you can leave some off).

5.8g Satisfy yourself that you are happy with the arrangement before you replace the glass.

5.8h The installation should now be complete

6. OPERATING INSTRUCTIONS

WARNING! Do not operate the appliance if it is damaged or has malfunctioned. If you suspect the appliance is damaged or has malfunctioned call a qualified service engineer to inspect the appliance, and replace any part of the electrical system if necessary, before reuse.

WARNING! To reduce the risk of fire, keep textiles, curtains, or any other flammable material a minimum distance of 1 meter from the air outlet.

MAKE SURE the plug fits tight in the outlet. Faulty wall outlet connections or loose plugs can cause the outlet to overheat.

Do not disconnect the power at the mains supply whilst the appliance is running. Use the functions on the remote to turn the fire off and ensure the mains switch has been moved to the off position before disconnecting.

PREPARATION BEFORE USE

6.1 The appliance can be operated by both remote control and the manual controls on the appliance.

NOTE: To use both remote and manual functions the manual on/off switch must be in 'ON' position. In order to prevent the product becoming too hot, there is 10s delay when turning on the heater and a 10s delay when turning off the heater fan.

Batteries

Ensure that the handset batteries are new and inserted correctly.

Main Power Switch

6.2 The mains power switch is located on the control panel located on the upper side of the heater box.

6.3 Switch ON (—) before operating either the remote or manual controls.

6.4 A long beep is heard to indicate the fire is ready for use.

6a. MANUAL CONTROL PANEL

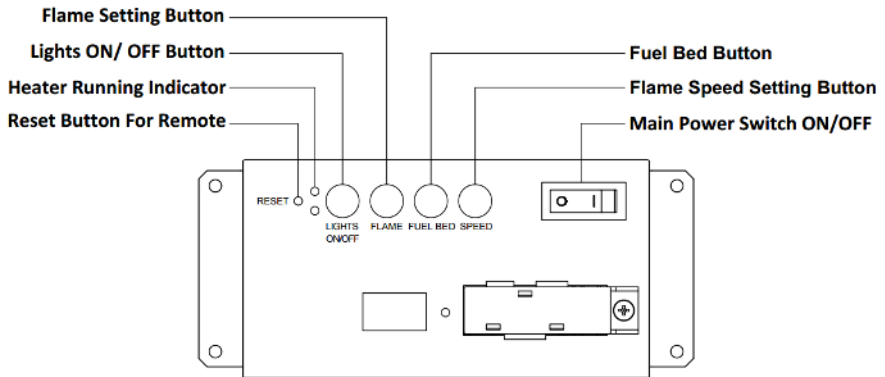

NOTE: The manual button controls basic functions, not a full range of controls. Use the remote hand set to carry out all functions.

6a.1 The manual buttons are located at the upper of the appliance.

6a.2 Press "LIGHTS ON/OFF" to turn on or turn off both the flame and mood light at the same time.

6a.3 Press "FLAME" button to select the colour of flame (3 kinds) or return to the OFF position.

6a.4 Press "FUEL BED " button to select the colour of fuel bed (13 kinds) or return to the OFF position.

6a.5 Press "SPEED " button to select the speed of flame (5 kinds).

NOTE: The controls on appliance will lose the memory for all function settings when the switch is set to the Off Position.

When the remote runs out of power or when you change the batteries, only the flame function will lose memory and will not affect the timer settings, however, the clock may need adjusting.

6b. REMOTE CONTROLS

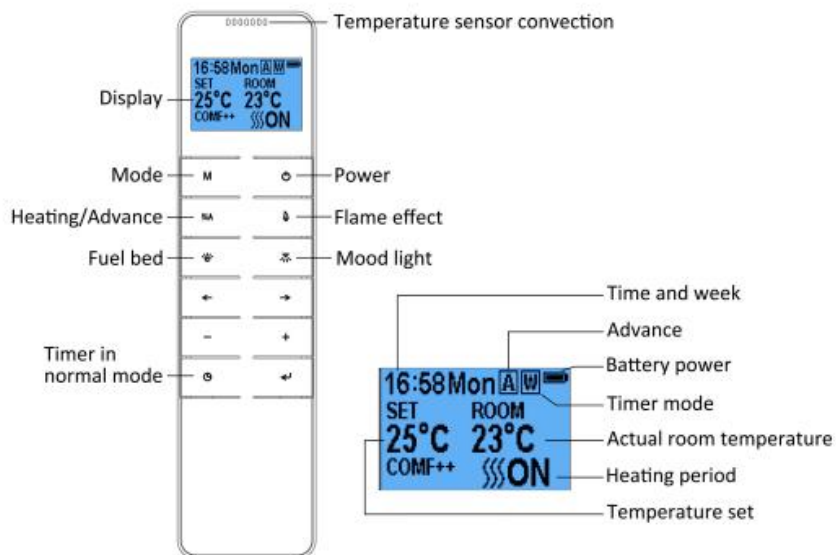

NOTE: This is thermostatic remote control. The remote should be in the same room as fireplace and placed on a flat surface. It must be placed away from the fire so the hot air will not blow on it and affect thermostatic reading.

The communication frequency between the fire and remote has already been set up. If you cannot use the remote with the fire, please follow instructions Step.6b37 to initiate this connection in point.

Standby for Remote Handset

6b.1 The screen shown to the right is when the remote handset is in standby condition.

Before Day/Time set up



Turn on/off

6b.2 Press  to turn on the flame effect, turn off flame effect and heater when in normal mode.

After Day/Time set up



6b.3 Press  to turn on/off the flame effect under daily and weekly timer mode.

Flame Effect

- 6b.4 Press  to enter the flame effect adjustment screen.
- 6b.5 Press the '←' and '→' button to select the 3 Kinds of flame effect.
- 6b.6 Press the '+' and '-' button to select the 5 brightness of flame effect and OFF settings.



Fuel Bed Colour

- 6b.7 Press  to enter the fuel bed adjustment screen.
- 6b.8 Press the '←' and '→' button to cycle through the 13 colours of fuel bed or a colour-cycle mode.
- 6b.9 Press the '+' and '-' button to to select the 5 brightness of fuel bed and OFF settings.

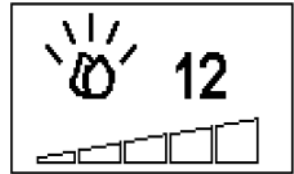

Mood Light

Note: If mood lights are not connected, please ensure the brightness is set to zero.

- 6b.10 Press  to enter the mood light adjustment screen.
- 6b.11 Press the '←' and '→' button to cycle through the 13 colours of mood light or a colour-cycle mode.
- 6b.12 Press the '+' and '-' button to to select the 5 brightness of mood light and OFF settings.



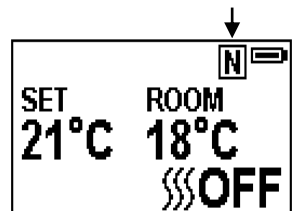

Normal Mode

- 6b.13 Normal control mode is factory set. If it is not, then press **M** button until the logo  shows up at the upper right corner of the



screen.

6b.14 Press the '+' and '-' button to adjust the temperature from 17°C to 25°C by 2 intervals.

6b.15 Press  A button to turn on/off heat,  ON、 OFF will show at the lower of the screen.

NOTE: It is normal for the fan heater to stop running for periods of time. This happens because the room temperature is at or above the temperature set on the remote control. The heater indicator will be turned off after 10s if you have the flame ON. The heater indicator will stay ON if you use the heating function only.



Count Down Timer



NOTE: This setting is only for normal mode. It allows the appliance to go into standby after a set period of time.

6b.16 Press  to cycle through the settings from Off and 0.5 hours to 9 hours. The timer logo and time will show on the screen.

The heater must be in ON position.

The heater can be automatically run by using daily timer and weekly timer on the remote.

Set up Day, Time and Comfortable temperature.

6b.17 Press  to turn on the remote handset. Hold the button  for 3 seconds to enter the setting screen.

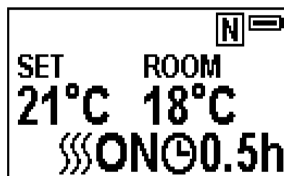

6b.18 Press the '←' and '→' button to choose Day, Time or your comfortable temperature. The character selected will be highlighted.

6b.19 Pressing the '+' and '-' button will adjust the number.

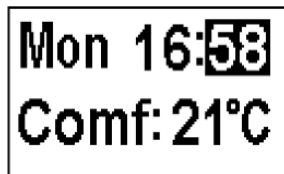

- Time: 24-hour system
- Select your comfortable temperature from 15-25°C.
- Temperature unit: °C、°F

Daily Timer Heating

6b.20 The following are preset heating periods, which can be altered if desired

06:00 until 08:30

17:00 until 22:00

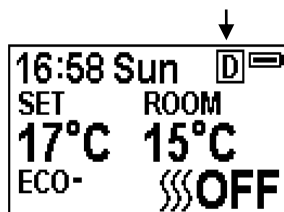

6b.21 Hold the arrow symbol button  for 6 seconds to enter The daily timer setting. Max 3 timed Heating periods per day.

6b.22 Hold the button  for 6 seconds to enter The daily timer setting. Max 3 timed Heating periods for a day.

- Press ‘←’ or ‘→’ to choose hour or minute, press ‘+’ or ‘-’ to set the time.
- Minute will increase/decrease by 15 minutes per press.
- Hold  for 3 seconds or wait for 10 seconds to save and exit the heating time period setting.

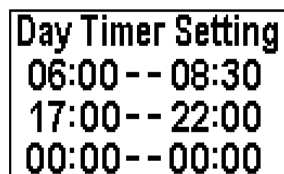

6b.23 Adjusting the set temperature

- Press the ‘+’ or ‘-’ button to increase or decrease the temperature on the basis of your comfortable temperature setting.
- ECO means 2°C lower than your comfortable temperature setting,
ECO- means 4°C lower,
COMF+ means 2°C higher,
COMF++ means 4°C higher.

6b.24 To check your daily timer settings, press .

6b.25 If heating needs to be turned off, it will be necessary to go back to the Normal Mode to turn off.

Week Timer Heating

6b.26 The following are preset heating periods, which can be altered if desired.

From Monday to Friday

06:00 until 08:30

17:00 until 22:00

From Saturday to Sunday

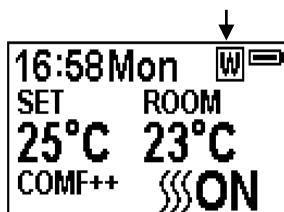

06:30 until 09:30
11:00 until 13:00
17:00 until 22:00

6b.27 Press **M** until **W** shows at the upper right corner of the screen, then enter the week timer heating mode.

6b.28 Hold **↵** button for 6 seconds to enter the week timer setting.

- Press '**←**' or '**→**' to move the cursor (a flashing underline), press the **↵** button in the corresponding week position to select (the character is highlighted) or cancel (the character is displayed normally) the current setting. Several days can be selected together.
- Press the '**→**' button to move the cursor to the time period setting area. Press '**←**' or '**→**' to choose hour or minute, press '**+**' or '**-**' to set the number.
- Max 3 heating periods for a day.
- Minute will increase/decrease by 15 minutes per press.
- Press the **↵** to set the heating time for the selected day(s) and return to the week line.
- Hold **↵** for 3s or wait for 10s to save and exit the heating time period setting.

Mo	Tu	We	Th	Fr	Sa	Su
06:00	--				08:30	
17:00	--				22:00	

6b.29 Press **↵**, '**←**' and '**→**' to check your week Timer settings.

6b.30 If heating needs to be turned off, it will be necessary to go back to the Normal Control Mode to turn off.

Mo	Tu	We	Th	Fr	Sa	Su
06:30	--				09:30	
11:00	--				13:00	
17:00	--				22:00	

Advance Mode

6b.31 Under the daily and week timer mode, Press **≡ A**:

6b.32 To turn the heater off when the heater is on during a preset heating period.

6b.33 To turn the heater on when the heater is off in between preset heating periods.

↓

16:58	Mon	A	W	≡
SET		ROOM		
25°C		23°C		
COMF++		≡ ON		

Adaptive Start Control

6b.34 According to room temperature and set temperature, the heater will automatically come on in time to heat the room to the set temperature at the set time. For example, if your timer is set to start at 18:00 and temperature is set to 23°C, the fire will come on at 17:30 to ensure the room is 23°C at 18:00.

Window Open Detection

6b.35 When the transmitter detects a rapid drop in room temperature, it will be judged as a window open, the warning icon will be displayed and the heating will be turned off automatically.



6b.36 After the indoor temperature has risen or a manual override of the warning (by operating remote control) has been done, the fire will return to normal working state.

Set up the communication between the remote and appliance

6b.37 The below operations should be carried out before programming, when changing to a new remote or in the event the appliance cannot be controlled by the remote:

- Hold the reset button on the appliance for 3 seconds (pen Point may be needed) until you hear 3 short beeps from the unit, release the button.
- Press the  button on the remote, the programming is finished when you hear 1 long beep from the appliance.

6b.38 Resetting the code for remote control is necessary if the appliance operates wrongly or the remote control does not operate correctly.

- Open the back cover of the remote control.
- Press the Reset button on remote handset.
- Follow the steps 6b.37



Resetting the Thermal Cut Out

6b.39 The appliance is fitted with an Electronic Safety Control (E.S.). This is a safety device, which switches off the fire if, for any reason, the appliance overheats, e.g. when covered. If the heater stops operating while the flame effect continues working normally, this indicates that the E.S.



Control is in operation. The E.S. Control can only be re-set after the appliance has cooled down, and the appliance has been reset. Re-setting of the E.S. Control proceeds is as follows:

- 6b.40 Switch off the appliance (Manual On/Off switch) and leave it off for approximately 10-15 minutes.
- 6b.41 Remove any obstruction to the fan heater outlet or fan blades etc. Make sure that the power supply is disconnected with the plug socket outlet while doing this.
- 6b.42 Switch on the appliance and the E.S. Control will be re-set.
- 6b.43 Ensure that the appliance is functioning correctly. If the E.S. Control operates again, the appliance should be checked by a competent electrician.

7. MAINTENANCE

WARNING: Before any maintenance or cleaning of the exterior of the fireplace, the unit should be disconnected from the power supply until it is cool off.

Remote Handset Battery Replacement

- 7.1 When the batteries are at full power, the battery symbol will show 
- 7.2 When the batteries are half full, the battery symbol will show 
- 7.3 When the batteries are out of power and need replacing immediately, the battery symbol will show 
- 7.4 Battery replacement is recommended after 1 year. The batteries are 1.5V alkaline AAA, batteries.
- 7.5 Dispose of old batteries at an appropriate recycling facility.

Cleaning the Fireplace

Cleaning or polishing products are not recommended. Fingerprints or other marks on the front glass panel can be removed by a piece of soft, damp, lint-free cloth with a good quality household glass cleaner. The front glass panel should always be completely dried with a clean, lint-free cloth or paper towel.

CAUTION: Abrasive cleaners should not be used on the glass panel. Liquids should not be sprayed directly onto any surface of the unit.

8. OTHERS



Environment

Meaning of crossed –out wheeled dustbin:

Electrical appliances should not be disposed as unsorted municipal waste. Separate collection facilities should be used in the disposal of electrical appliances. Contact your local government for the information about the available collection systems. If electrical appliances are disposed of in landfills or dumps, hazardous substances can leak into the groundwater and get into the food chain, damaging your health and well-being. When old appliances are replaced by the new ones, it is a legal oblige for the retailer to take back the old appliance for disposals at least free of charge.



This fire complies with the Safety Standards EN 60335-1 and EN 60335-2-30 which covers the essential requirements of the Low Voltage Directive 2014/35/EU and the EMC standards EN 55014-1; EN 55014-2; EN 61000-3-2 and EN 61000-3-3 which covers the essential requirements of the European Electro Magnetic Compatibility 2014/30/EU, and the RED standards EN300220-2, EN301489-1, EN301489-3 and EN6247 which covers the essential requirements of the European Radio Equipment Directive 2014/53/EU.

Control PCB	Remote Control Receiver	Remote Control Transmitter
Hardware: RC01-047A01 Software: V1	Hardware: RF290B V1.2	Frequency: ASK/OOK 433.92MHZ Maximum transmit power: 10mW Hardware:RF290A-TX-V1.3 Software:V2.4.1

Charlton & Jenrick Ltd

Unit D, Stafford Park 2, Telford, Shropshire, TF3 3AR

Tel: (0845) 5195 991 Fax (0845) 5195 992 www.charltonandjenrick.co.uk